



Statewide Education Network

Advisory Committee

June 20, 2024



• Agenda

- Brief Introductions of new members
- Broadband Updates
- Statewide Education Network (SEN) Status
- School Participants – Transition: Memorandum of Agreement & Status
- SEN Consortium – Cybersecurity & E-rate Pilot
- SEN Educational/Shared Content – Discussion
- SEN Phase 3 RFP: Fall 2024
- Other Items / Open Discussion

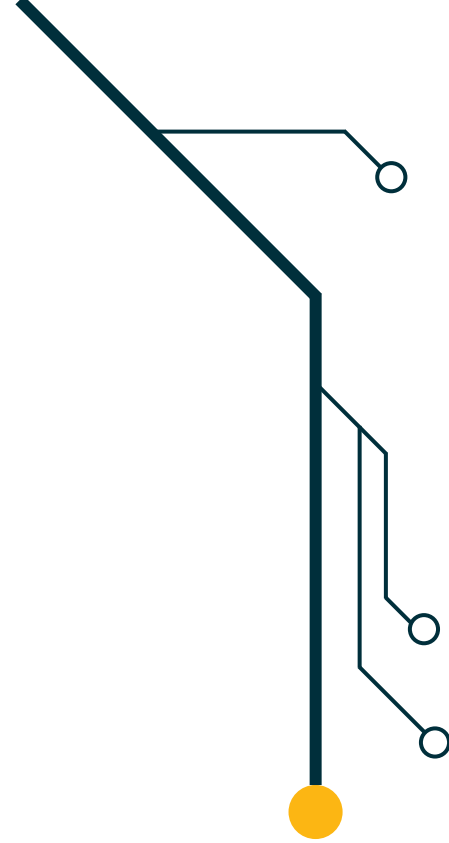

Broadband Updates - BEAD

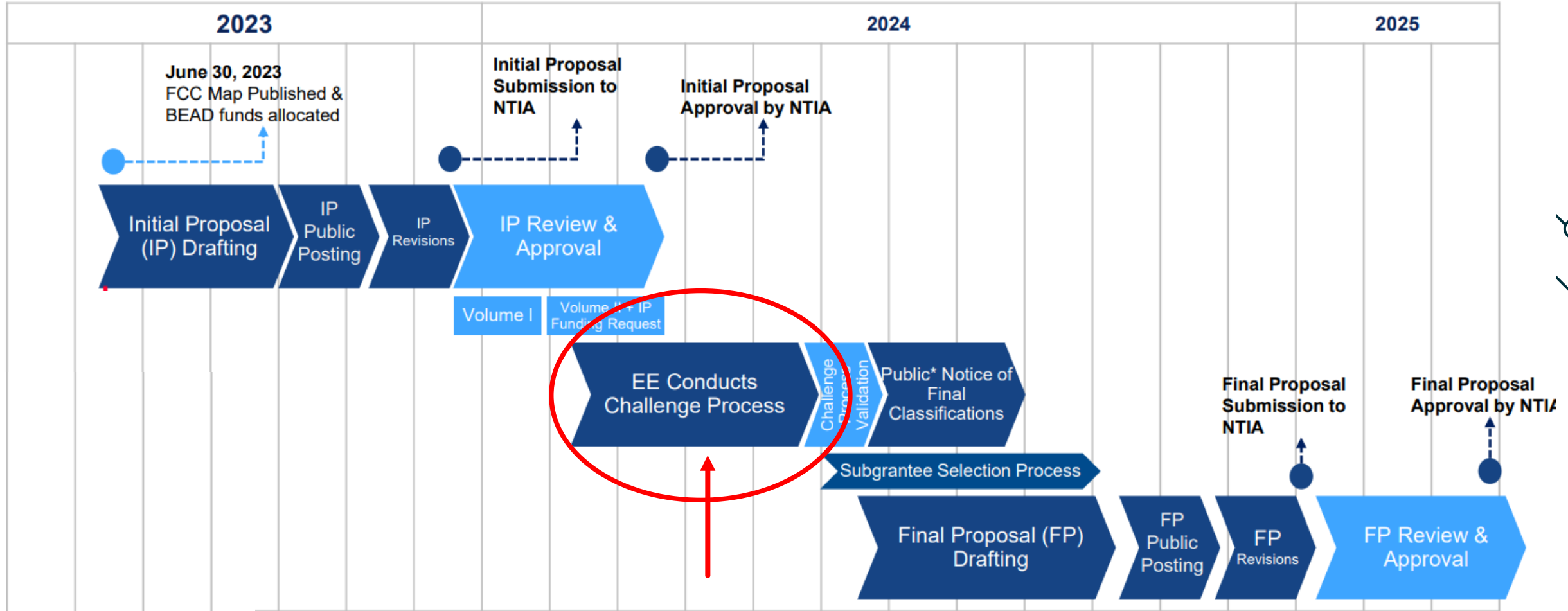

*Per the BEAD NOFO, an Eligible Entity must provide public notice of the final classification of each unserved location, underserved location, or Eligible Community Anchor Institution within the jurisdiction of the Eligible Entity after resolving each challenge and at least 60 days before allocating grant funds for network deployment.

Broadband Updates

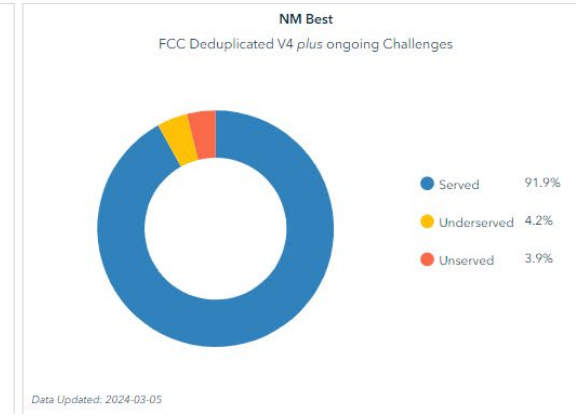
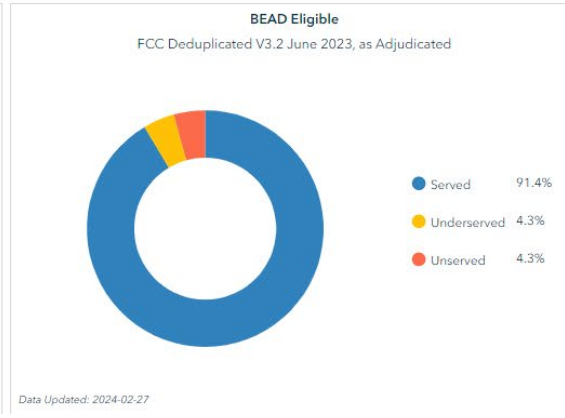
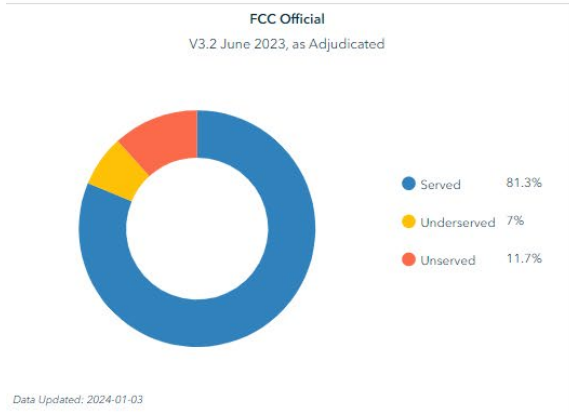
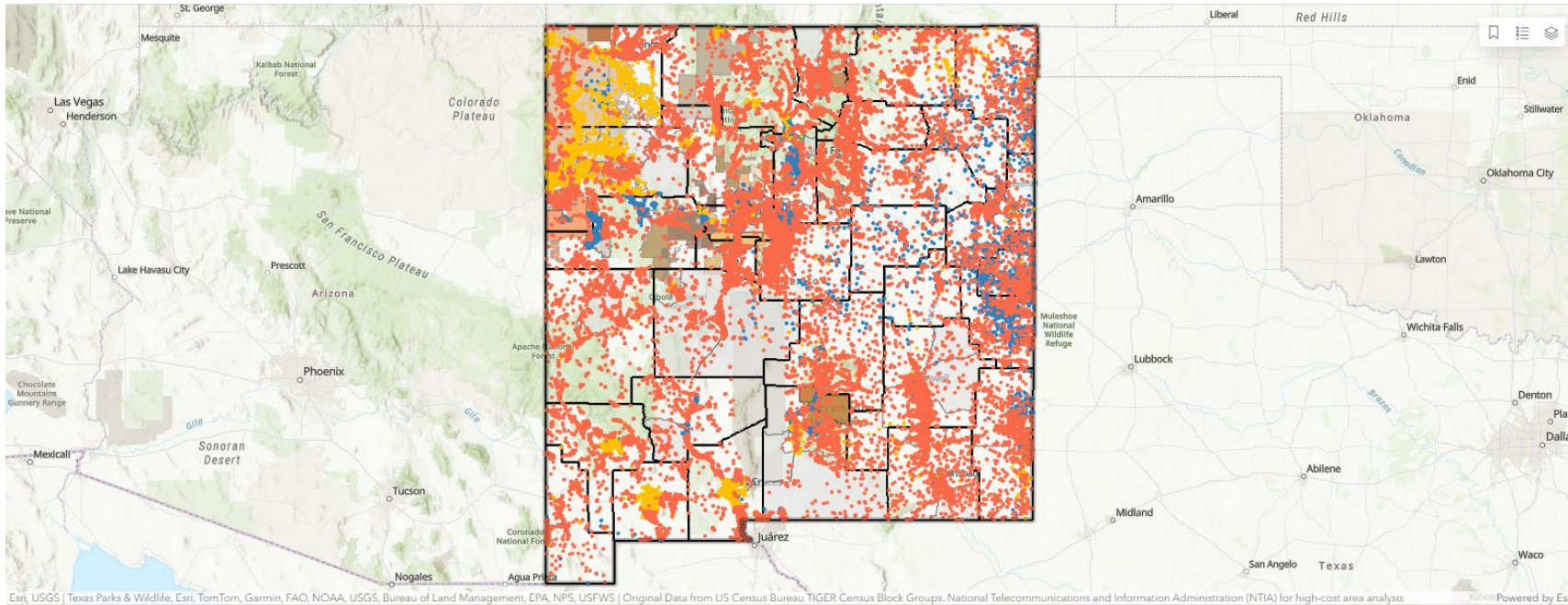

Broadband Updates – Digital Equity

- Digital Equity Capacity Grant Program Application
- NM Digital Equity Plan
- New Mexico 1st Allocation: \$8.67M
- Expected August 28, 2024
- Digital Literacy / Access to Devices / Affordability

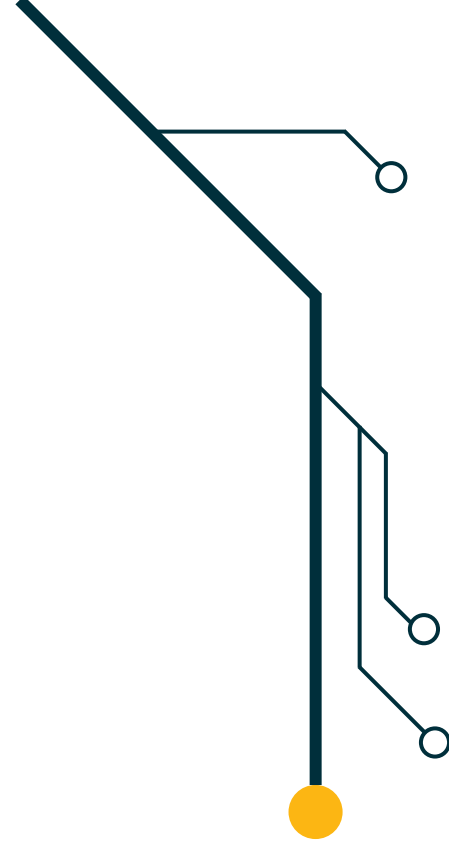

What is the Statewide Education Network (SEN)?

- <https://youtu.be/WgdkZjFmVUY>
- Network coordinated by the state, leveraging Internet Service Providers' existing broadband infrastructure and services.
- Will connect all public schools (K12) who participate together and to secure internet. Voluntary participation.
- Other entities could participate: libraries, HigherEd, museums, state parks...
- Will serve as the foundation for other connectivity needs: students, telehealth/rural health, courts, municipalities etc... for the incremental cost.

SEN Benefits:

- **Educational: Support EdTech. Allow sharing of instructional and professional resources between all the participants.**
- Administrative: reduce burden of planning, procurement, contracting, E-rate paperwork, billing...
- Cost reduction: reduction or elimination of schools' share (after E-rate).
- Technical support: provide specialized resources to (small) schools.
- Cybersecurity risk reduction.

E-Rate / Path to Sustainability:

- **E-Rate Central has filed the Form 471 on behalf of the SEN.**
- For the first year SEN participants should continue to file a Form 471 for Internet access.
- The Connect New Mexico and E-Rate Central team will support you with any questions on your application.
- USAC may ask whether you are requesting duplicative services if this happens contact E-Rate Central for assistance.
- Please call E-Rate Central's New Mexico helpline (505) 456-4400 for support.

SEN Phase 1 Overview

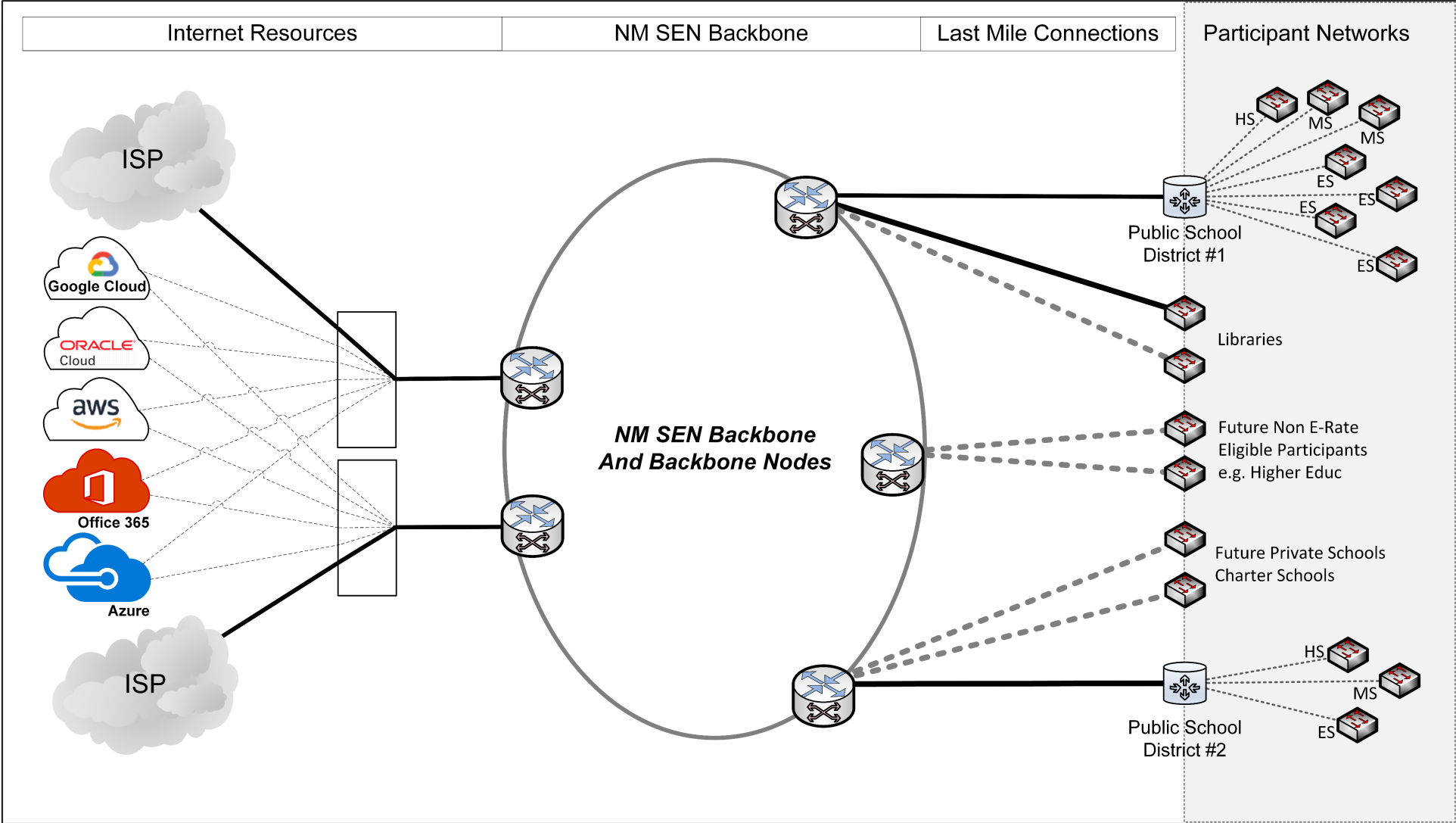

SEN

— SEN 100G Wave (Lumen)

- Future State-Coordinated
XXXG Wave (YY Vendor)
Alternative Path(s)

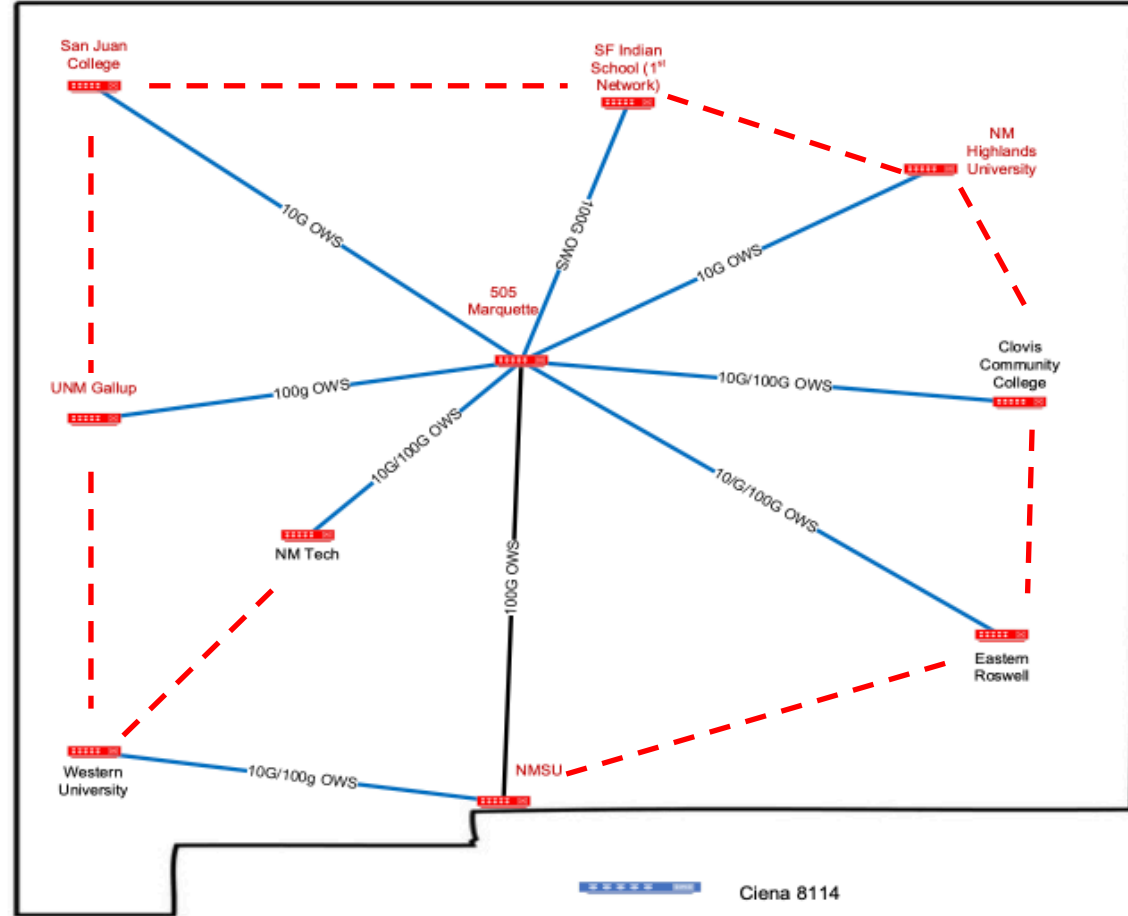

Connection Options

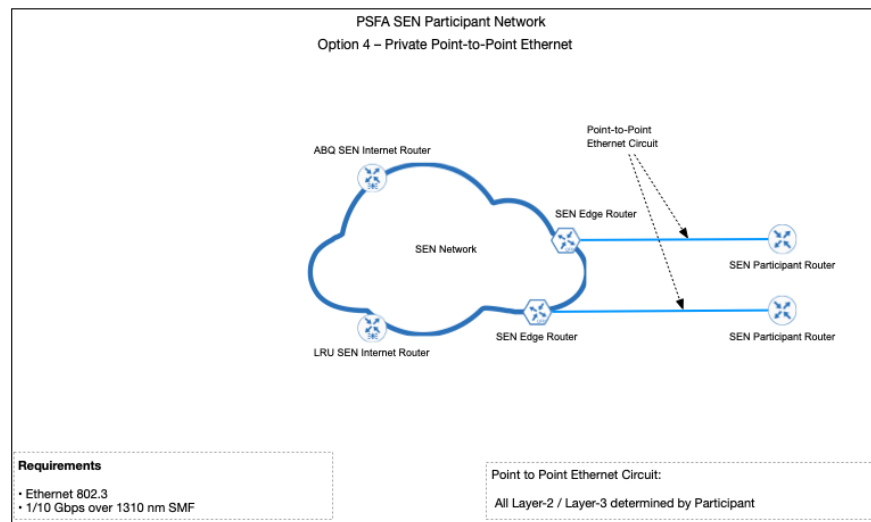
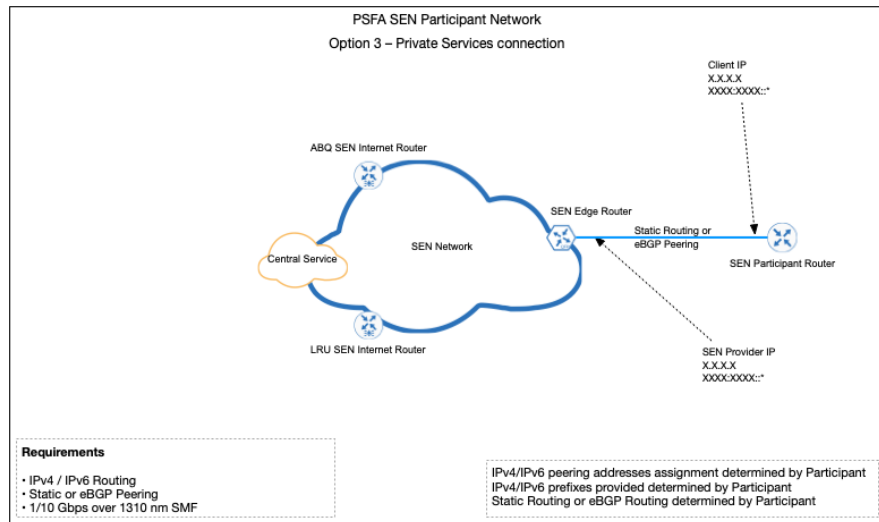
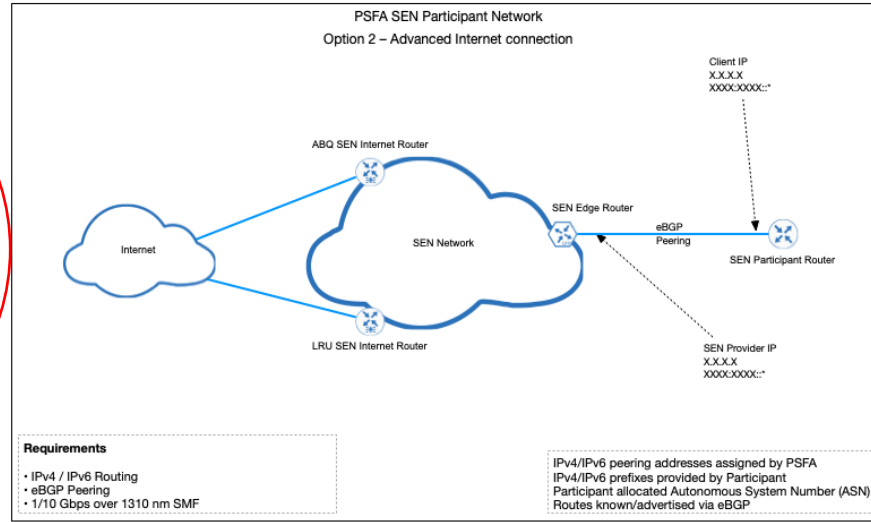
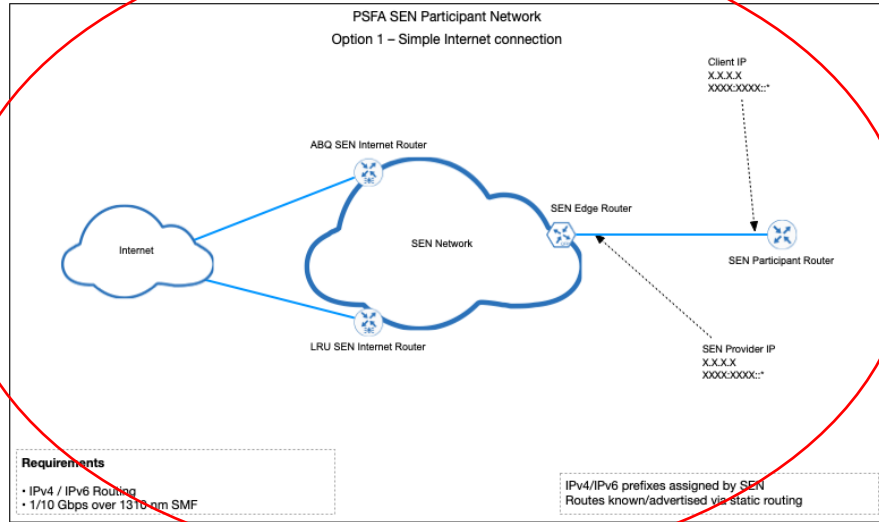

Completing the NM Broadband Highway

Internet:

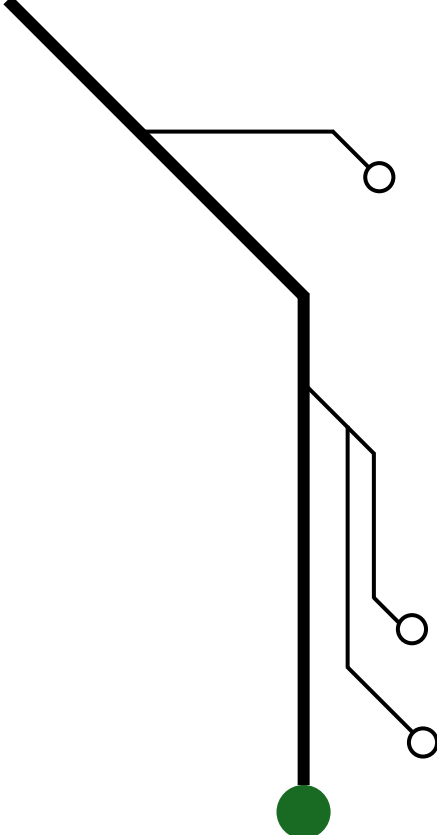
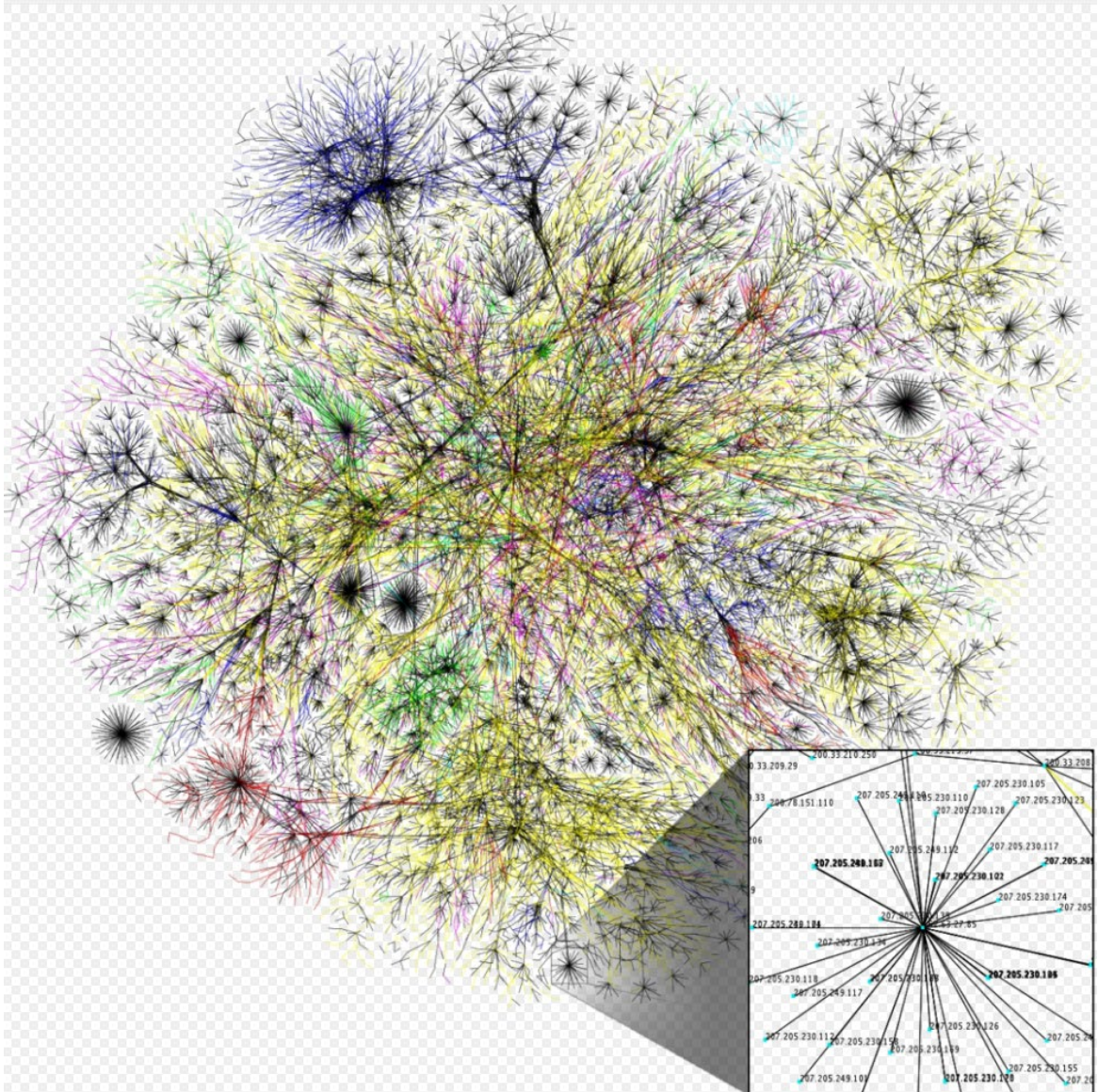

Completing the NM Broadband Highway

Internet:

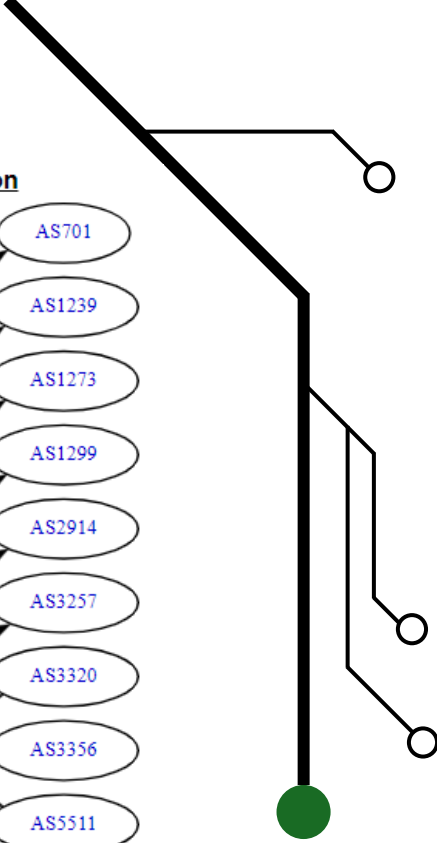
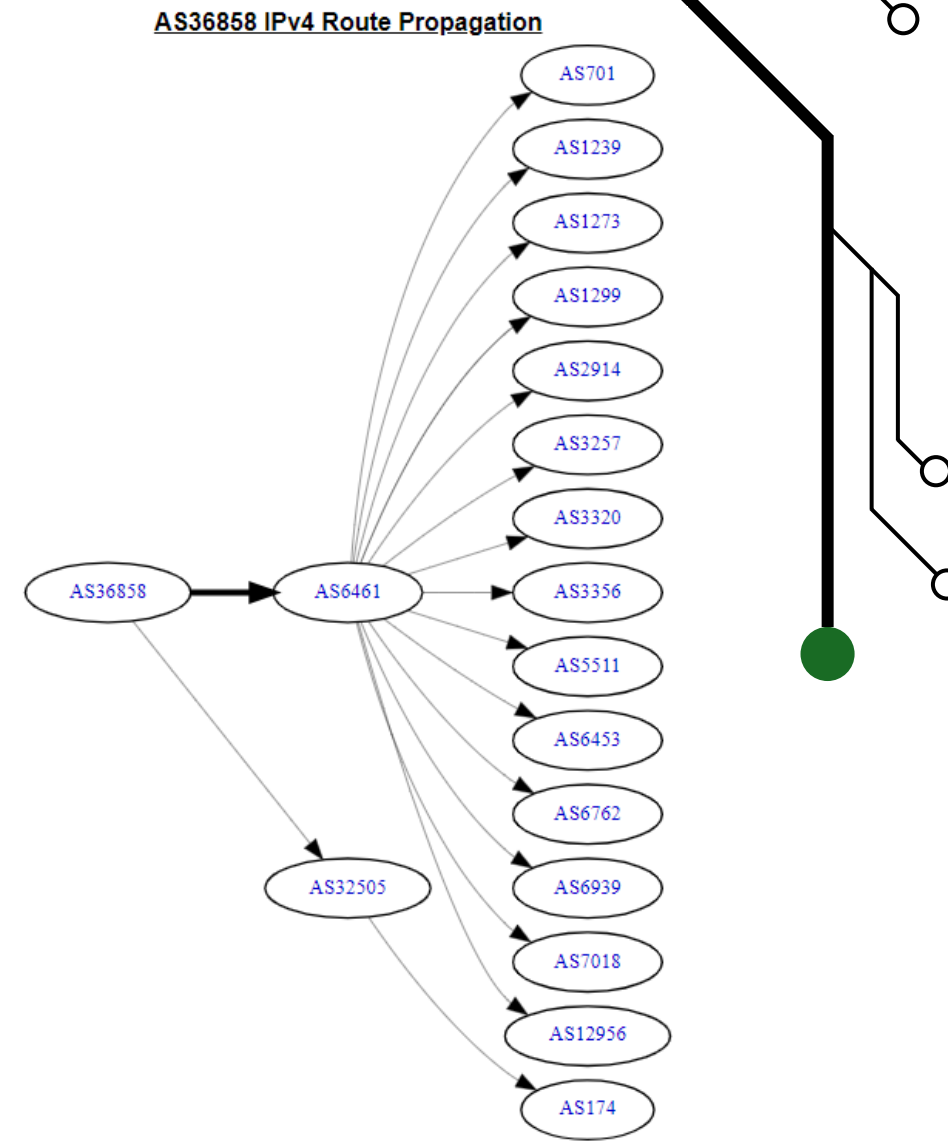
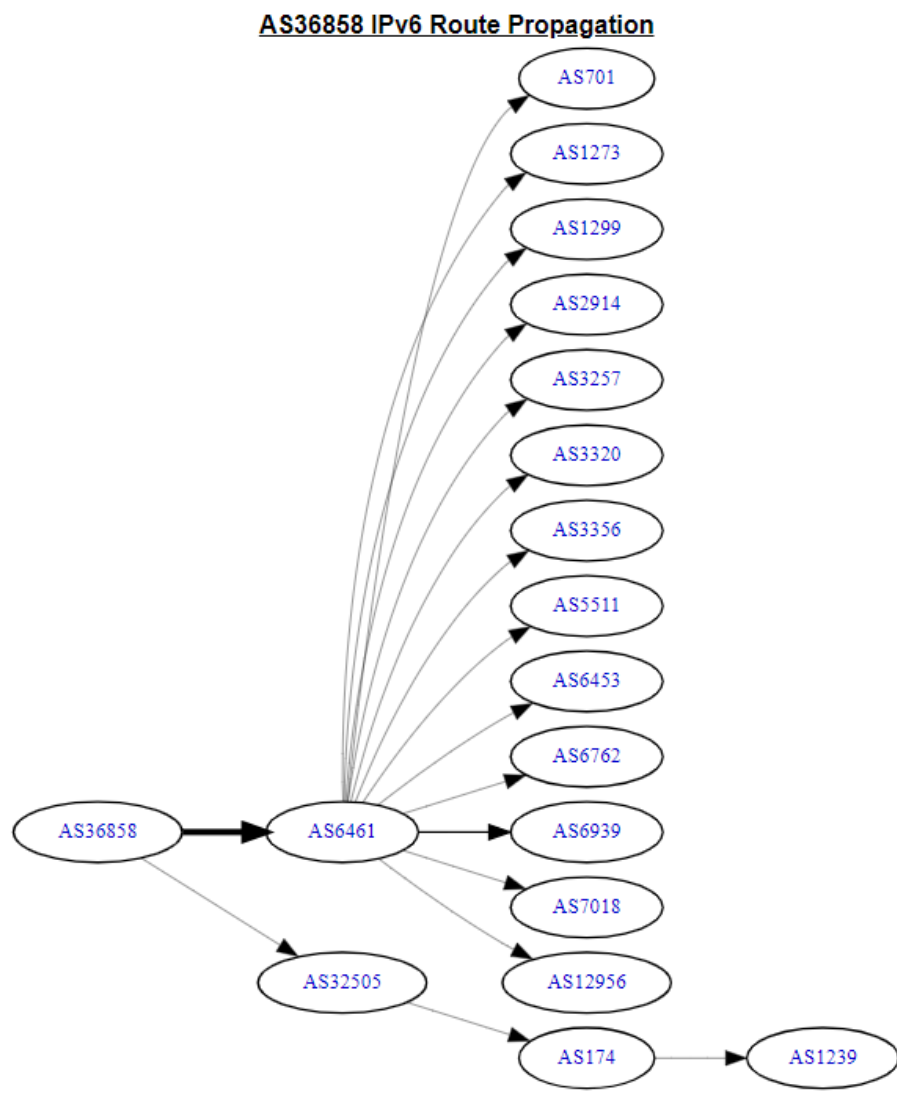

• SEN Milestones and Timeline

1. 1st SEN E-rate application (~\$500,000 / \$400,000 E-rate estimated): **Complete**
2. Backbone circuit (100Gbps) turnup Albuquerque - Las Cruces: **Complete**
3. Internet circuits turnup Albuquerque (Zayo) & Las Cruces (Conterra): **Complete**
4. SEN Equipment Installation & Testing – Albuquerque & Las Cruces: **Complete**
 1. In Progress: Last Mile Circuits, SEN provisioning of CPE, SEN provisioning of participant paths;
 2. Tier 1 Support (Ticketing, basic resolution & escalation...)
 3. Configuring / Installing Network Management Equipment & Tools
5. Other Backbone circuits: June - As node sites ready:
 1. Silver City (WNMU), Farmington (SJC), Roswell (ENMU), Clovis (CCC), Gallup (UNM Gallup)
 2. Pending: Las Vegas (Highlands), Socorro (NMT), Santa Fe (SFIS)
6. SEN Equipment Installation: June - Farmington
7. Onboarding meetings/interviews - Ongoing
 1. Gadsden, Farmington, Mark Armijo, 21st Century Academy, Mountain Mahogany, Belen, Hatch, Los Alamos...
8. June / July: Switchover
 1. Gadsden, Farmington, Albuquerque Charters ...
 2. Availability of personnel and Last Mile circuit provisioning
9. July 1, 2024 SEN Operational

- SEN Milestones and Timeline

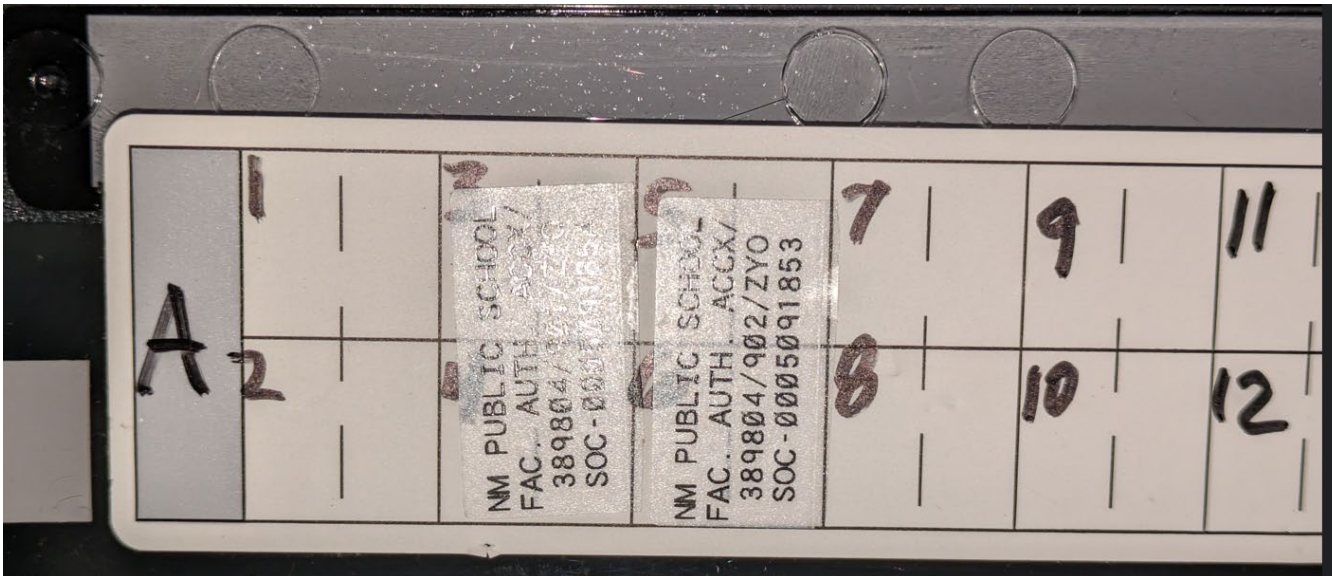

- SEN Milestones and Timeline

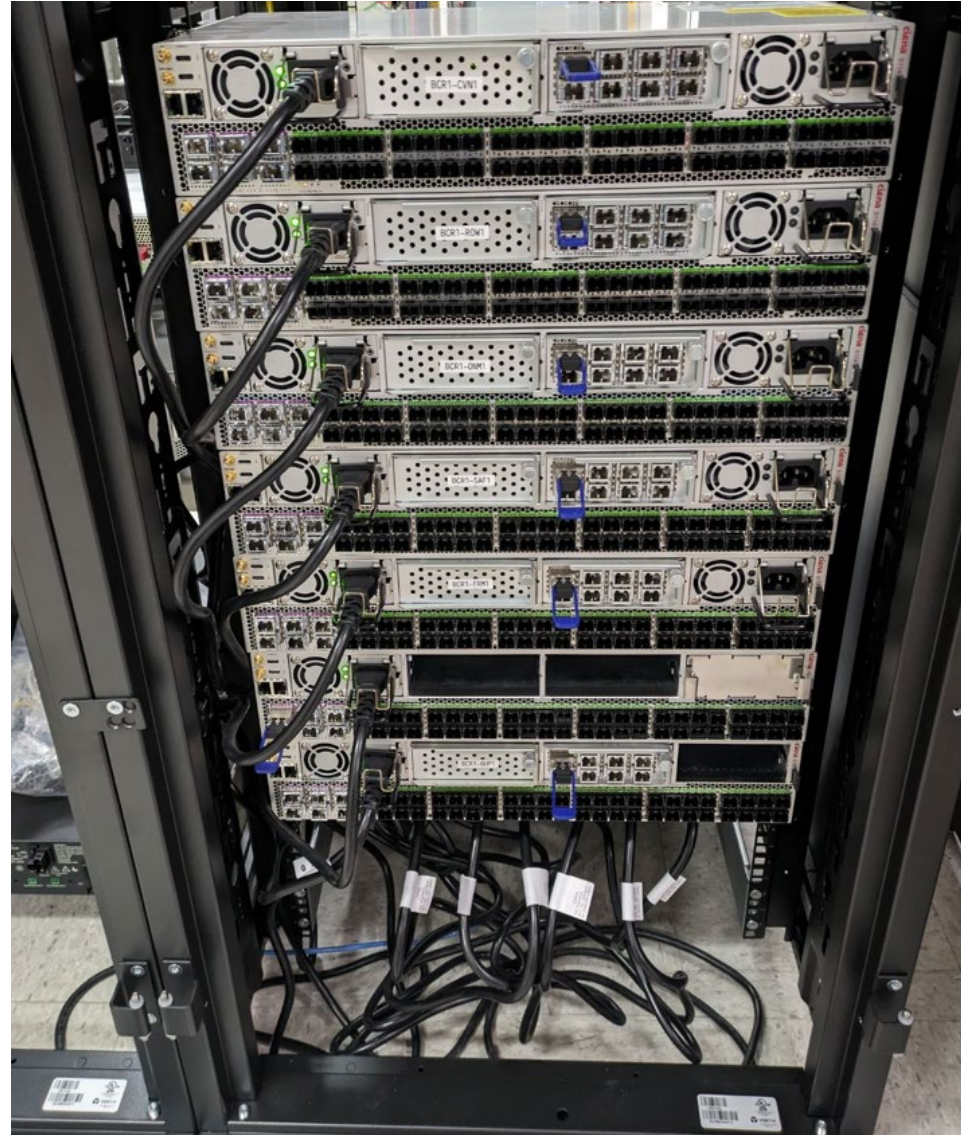
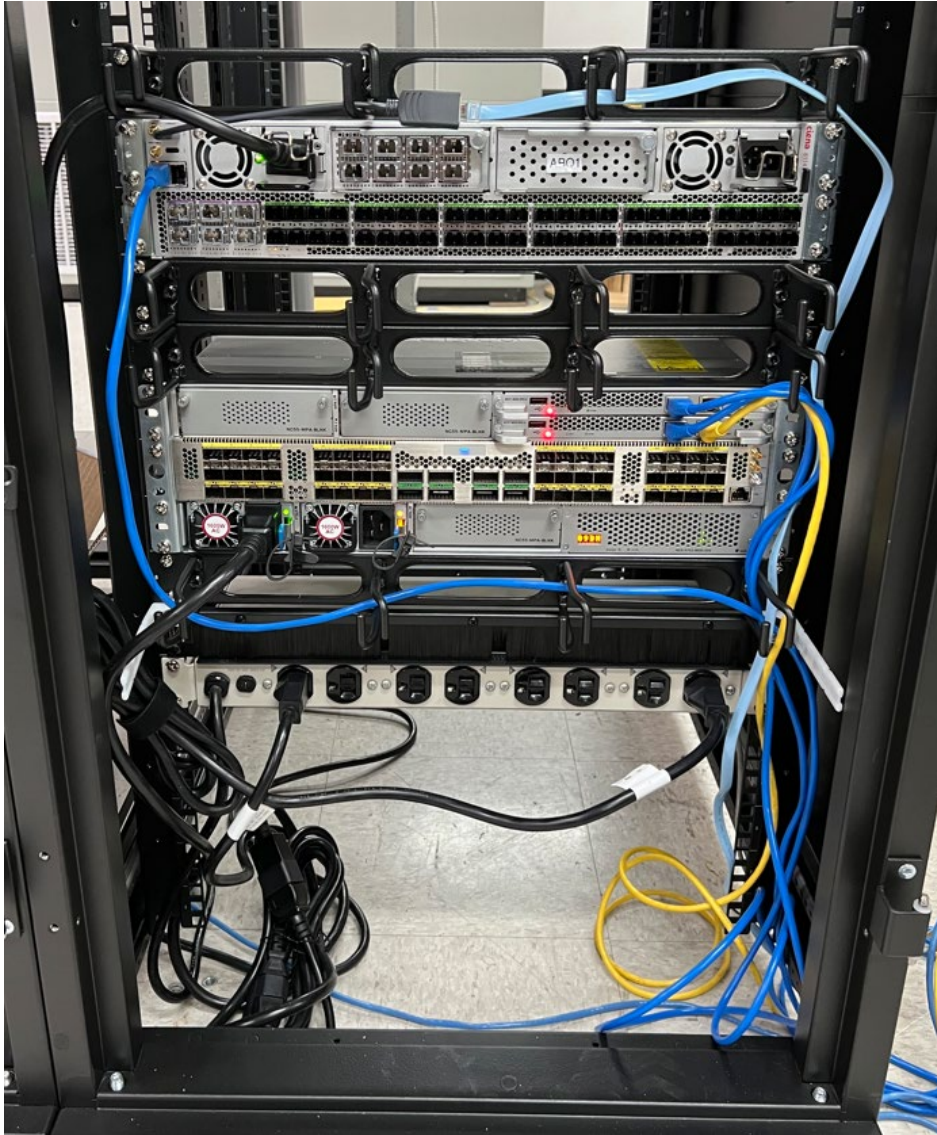

SEN Onboarding – Memorandum Of Agreement (MOA):

- SEN Service(s): Internet (Maintenance & Operations), Procurements, Contracts, Bill payment, E-rate...
- Participant:
 - Network Integrity (security measures, security policies, points of contact, collaboration, notifications, letters of agency etc...)
 - No Cost (First year) – advocating for this to be extended in perpetuity
 - Cost covered by current budgets / approved funding
 - Billing for schools: require process(es), personnel, state pays ultimately

SEN Cybersecurity – E-rate Pilot

- June - The FCC Approved an E-rate Cybersecurity Pilot
- \$200M over 3 Years
- SEN strategic goal: maximize E-rate funding (~\$1.5M)

SEN Cybersecurity – E-rate Pilot

- Two Phases
- Fall 2024 – Selection
- Looking for partners
- PED, NMSU, NMT, NM Office of Cybersecurity,
- K12 (Santa Fe, ...)
- Significance
 - Sustainability for cyber protection & risk reduction for schools

Questions for Initial Application:
A broad description of the proposed Pilot project, including, but not limited to, a description of the applicant’s goals and objectives for the proposed Pilot project, a description of how Pilot funding will be used for the proposed project, and the cybersecurity risks the proposed Pilot project will prevent or address.
The cybersecurity equipment and services the applicant plans to request as part of its proposed project, the ability of the project to be self-sustaining once established, and whether the applicant has a cybersecurity officer or other senior-level staff member designated to be the cybersecurity officer for its Pilot project.
Whether the applicant has previous experience implementing cybersecurity protections or measures (answered on a yes/no basis), how many years of prior experience the applicant has (answered by choosing from a preset menu of time ranges (e.g., 1 to 3 years)), and whether the applicant has experienced a cybersecurity incident within a year of the date of its application (answered on a “yes/no” basis), information about the applicant’s participation or planned participation in cybersecurity collaboration and/or information-sharing groups.
Whether the applicant has implemented, or begun implementing, any Education Department or CISA recommendations (answered on a “yes/no” basis), a description of any Education Department or CISA free or low-cost cybersecurity resources that an applicant currently utilizes or plans to utilize, or an explanation of what is preventing an applicant from utilizing these available resources.
An estimate of the total costs for the proposed Pilot project, information about how the applicant will cover the non-discount share of costs for the Pilot-eligible services, and information about other cybersecurity funding the applicant receives, or expects to receive, from other federal, state, local, or Tribal programs or sources.
Whether any of the ineligible services and equipment the applicant will purchase with its own resources to support the eligible cybersecurity equipment and services it plans to purchase with Pilot funding will have any ancillary capabilities that will allow it to capture data on cybersecurity threats and attacks, any free or low-cost cybersecurity resources that the applicant will require service providers to include in their bids, and whether the applicant will require its selected service provider(s) to capture and measure cost-effectiveness and cyber awareness/readiness data
A description of the applicant’s proposed metrics for the Pilot project, how they align with the applicant’s cybersecurity goals, how those metrics will be collected, and whether the applicant is prepared to share and report its cybersecurity metrics as part of the Pilot Program.

SEN Operations:

NSOC Level 0

This bootstrap structure is designed to offer the minimum staff needed to run and expand the NSOC until a more comprehensive structure is put into place.

Personnel

- **Local Helpdesk staff** to monitor tickets and attempt resolution using existing runbooks.
 - Preferably Junior Engineers who can learn to update automation and runbooks under supervision by Tier 2.
- **Sr. NetDevOps Engineer** to do project work and to take Tier 2 escalations to resolution, including automation and runbooks for next occurrence.
 - Proactively writes automation, trains Helpdesk/Junior Engineers, and transforms escalations into automation and runbooks.
- **Network Consultants** to do project work and handle specialized escalations
 - Network Architecture change
 - Network Hardware change
 - Solution Architecture

Workflow

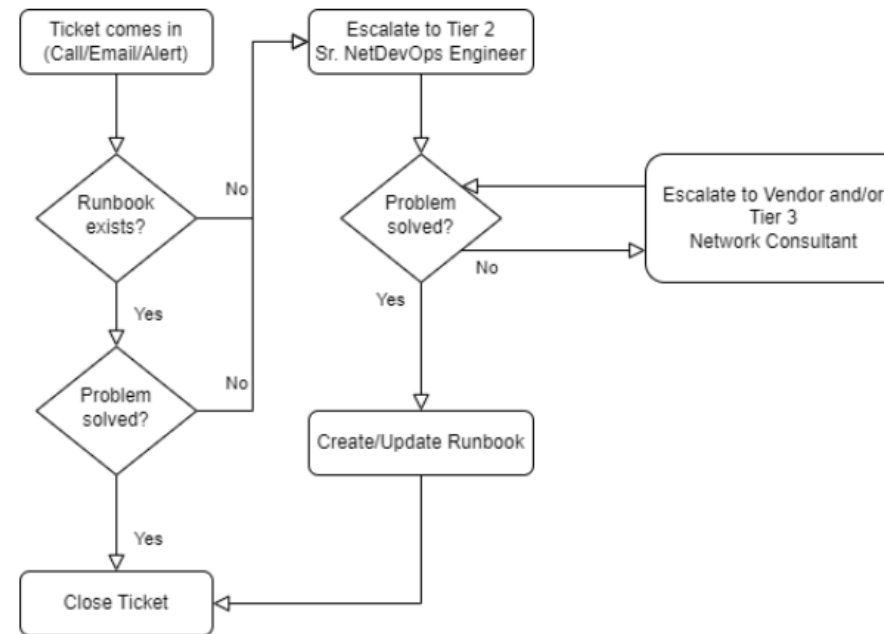

SEN Network & Security Operations Center (NSOC)

2

SEN Services (Networking / Security)

- **Internet (IPv6 First / IPv4), BGP Peering, Central Service, Private Point To Point**
- **DDoS Protection, IDPS, NOC / SOC, Helpdesk: 833-999-4SEN**
 - Protect
 - Detect
- **Near Future: Content filtering, managed firewall, secure DNS, Disaster Recovery...**
 - Respond & Recover

Connection Options: Central Service(s)

Define Central Service(s):

- Books (instruction)
- Videos
- Lesson Plans
- Online Classes
- Professional development materials
- Platforms (s.a. Zoom)
- Cloud
- Etc....

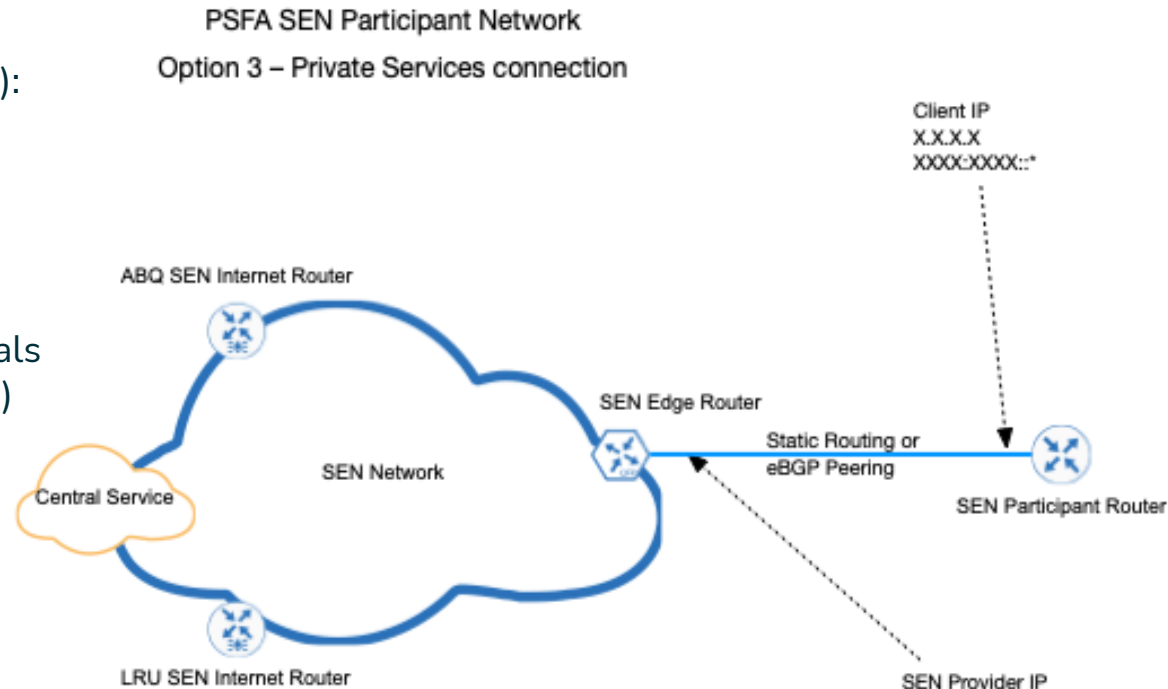

Requirements

- IPv4 / IPv6 Routing
- Static or eBGP Peering
- 1/10 Gbps over 1310 nm SMF

IPv4/IPv6 peering addresses assignment determined by Participant
IPv4/IPv6 prefixes provided determined by Participant
Static Routing or eBGP Routing determined by Participant

Connection Options: Point-to-Point

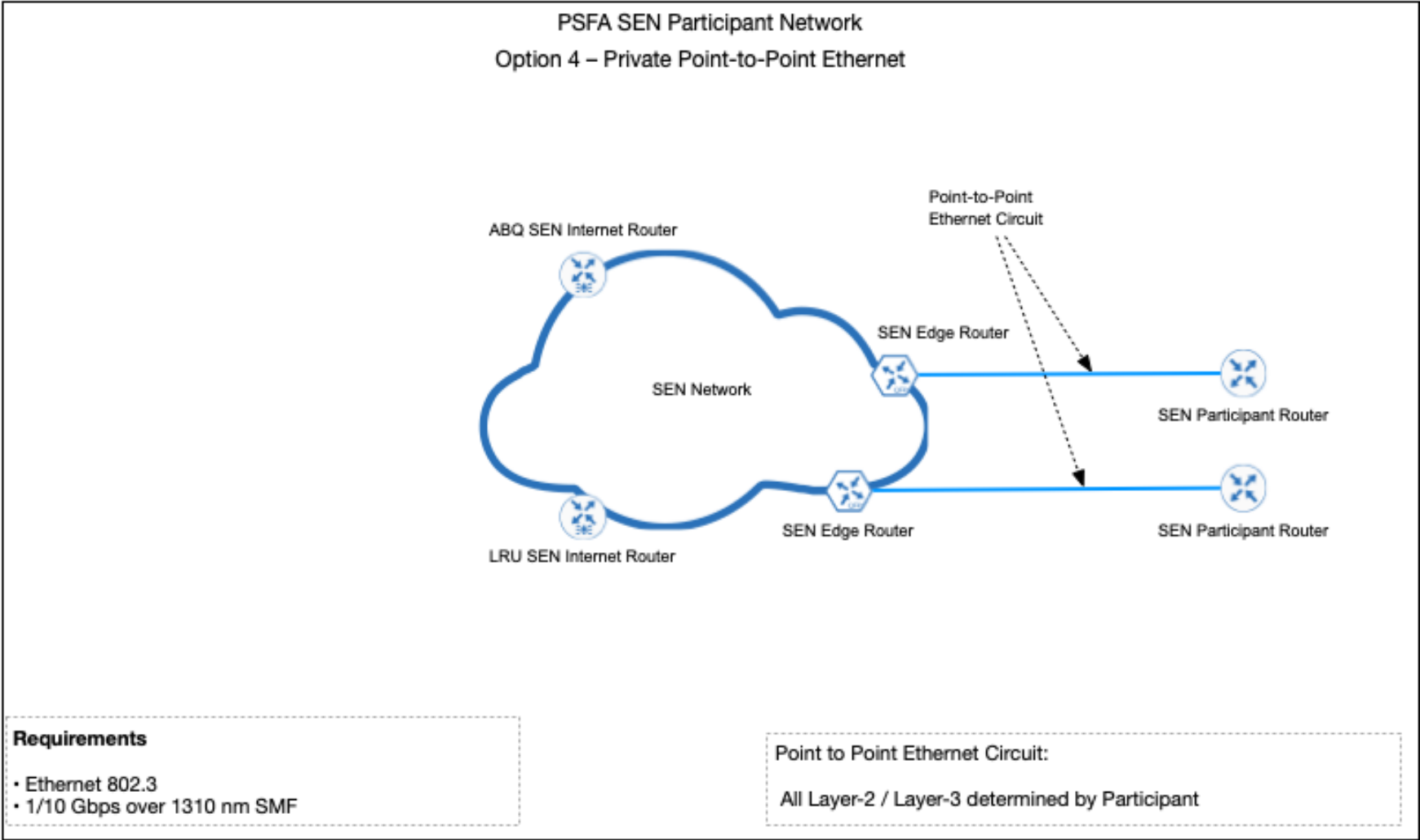

SEN Phasing & Procurements

- SEN Phase 1 : Deployment
- SEN RFP – Phase2: Under procurement
 - Timeline (estimated): Issue intent to award (August/September)
 - Negotiate & execute contracts
- **SEN RFP – Phase3: Fall 2024**
 - Contracts expiring 2025 (and beyond)
 - Secure Letters of Interest
 - Depends on the outcome of Phase 2 RFP
 - Include everyone – confusion for ISPs responding to RFP



Completing the NM Broadband Highway

SEN Nodes

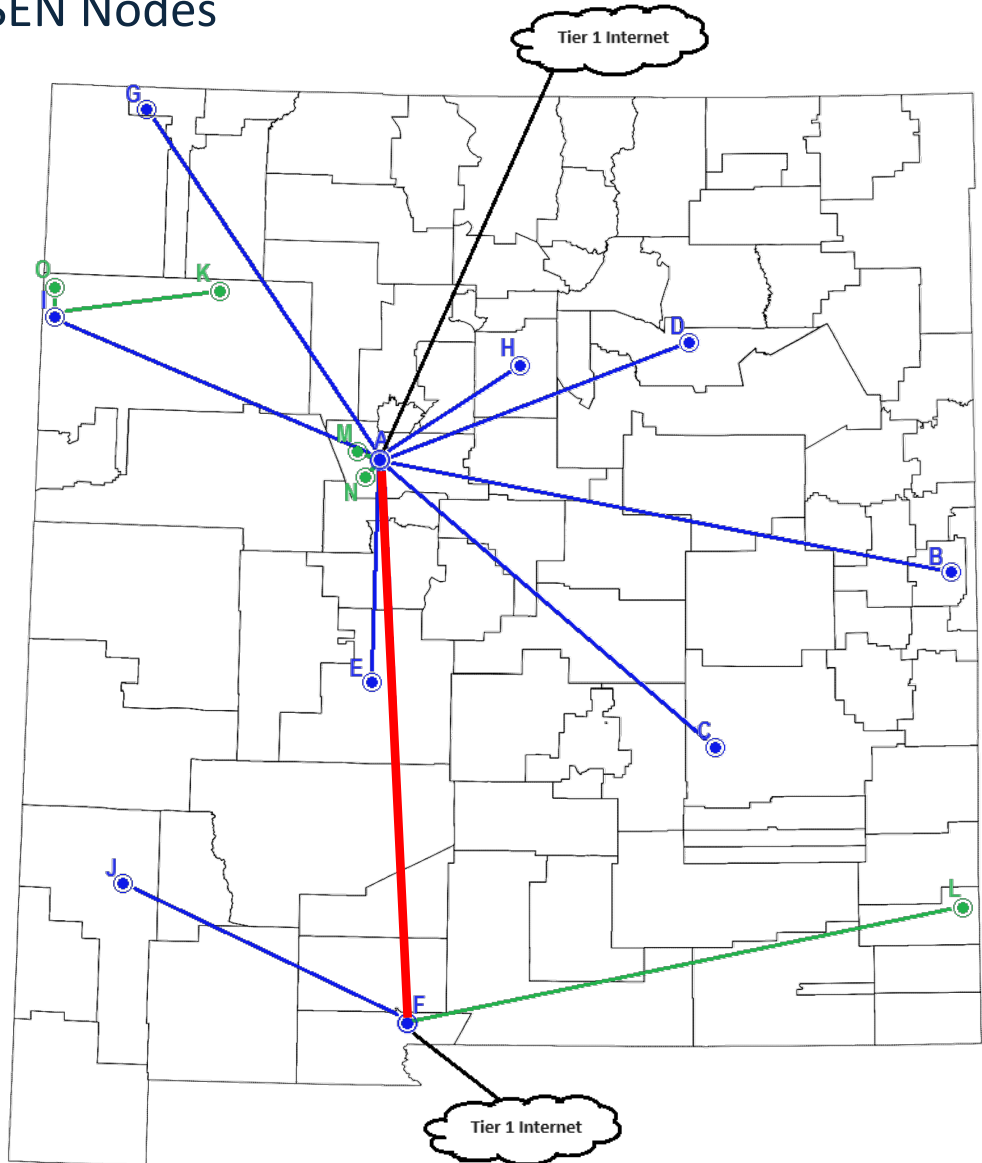

Existing Nodes:

- A- UNM 505 Marquette (Albuquerque)
- B- Clovis Community College
- C- Eastern NM University (Roswell)
- D- NM Highlands University (Las Vegas)
- E- NM Tech (Socorro)
- F- NMSU (Las Cruces)
- G- San Juan College (Farmington)
- H- SF Indian School (Santa Fe)
- I- UNM (Gallup)
- J- Western NM University (Silver City)

Potential New Nodes:

- K- Navajo Technical University
- L- New Mexico Junior College
- M- OSO Internet Exchange
- N- Big Byte Data Center
- O- Ya-Tah-Hey Neutral Aggregation Site

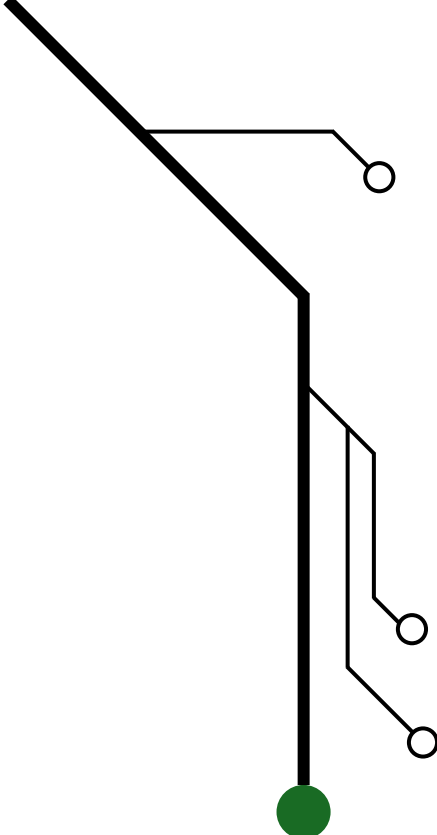

Completing the NM Broadband Highway

Last mile Participants

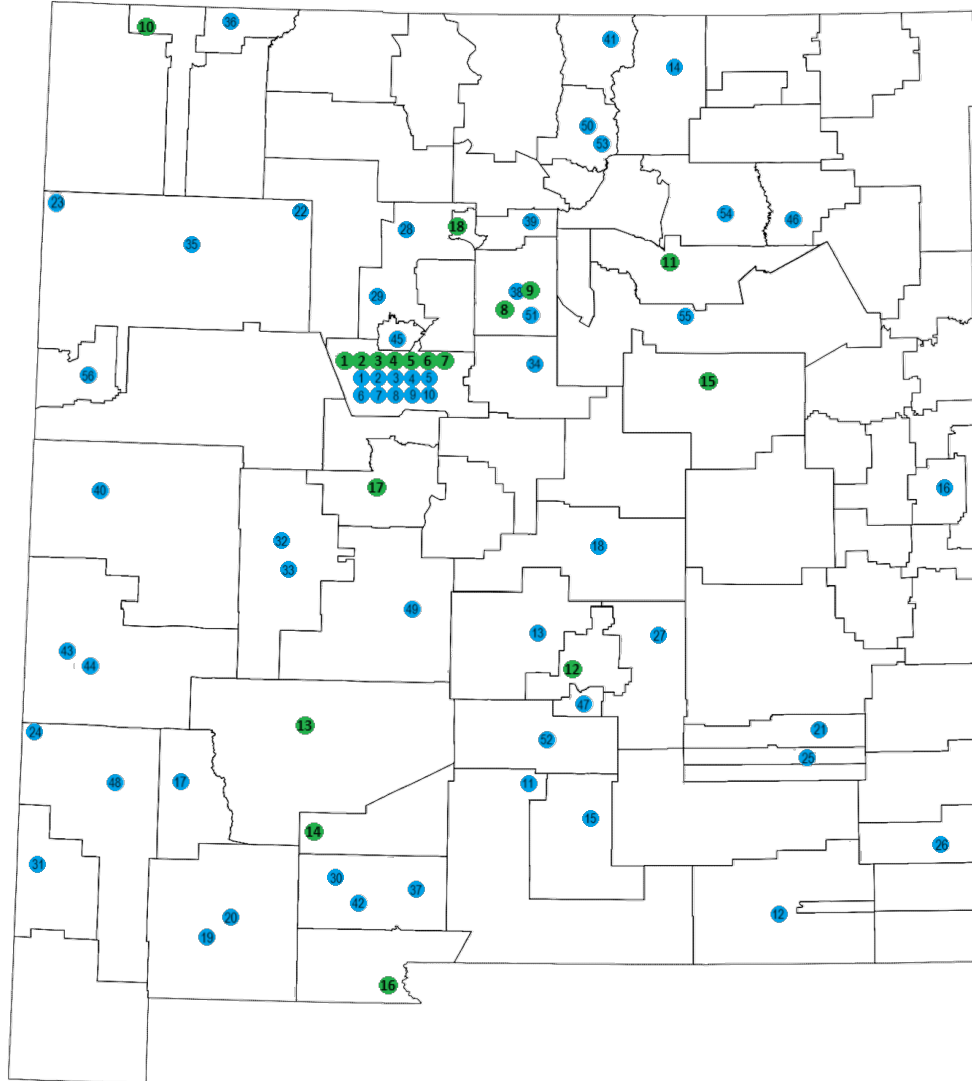

Phase 1

- 1 Dorn Charter School
- 2 Mark Armijo Academy
- 3 APS Data Center
- 4 Coral Cmty Charter School
- 5 Albuquerque School of Excellence
- 6 21st Century Public Academy
- 7 Mountain Mahogany Cmty School
- 8 Monte Del Sol Charter School
- 9 Santa Fe Public Schools
- 10 Farmington District Office
- 11 Las Vegas City Schools Data Center
- 12 Capitan Schools

- 13 Truth or Consequences Data Center
- 14 Hatch Valley Schools
- 15 Santa Rosa Schools
- 16 Gadsden Administrative Center
- 17 Belen Schools
- 18 Los Alamos Schools

Phase 2

- 1 Albuquerque Sign Language Academy
- 2 Amy Biehl High School
- 3 Cien Aguas International School
- 4 Cottonwood Classical Prep School
- 5 Gordon Bernell Charter School
- 6 Health Leadership High School
- 7 La Academia De Esperanza
- 8 Los Puentes Charter School
- 9 New Mexico International School
- 10 Technology Leadership High School
- 11 Alamogordo Public School District
- 12 Carlsbad Municipal Schools
- 13 Carrizozo Municipal Schools
- 14 Cimarron Mun School District
- 15 Cloudcroft Mun School District
- 16 Clovis Municipal Schools
- 17 Cobre Consolidated School District
- 18 Corona Public Schools
- 19 Deming Cesar Chavez High School

- 20 Deming Data Center
- 21 Dexter School District
- 22 Diné College Tribal Library
- 23 DEAP
- 24 Glenwood Library
- 25 Hagerman Municipal School District
- 26 Hobbs Municipal School District
- 27 Hondo Valley School District
- 28 Jemez Mountain (NCC)
- 29 Jemez Valley (NCC)
- 30 Las Cruces Public Schools
- 31 Lordsburg Municipal Schools
- 32 Magdalena Elementary School
- 33 Magdalena Library
- 34 MESD Network Operations
- 35 Middle College High School
- 36 Mosaic Academy
- 37 New America School - Las Cruces
- 38 New Mexico School For The Deaf

- 39 Pojoaque Central Office
- 40 Quemado Independent School District
- 41 Questa High School
- 42 Raices del Saber Xinachtli School
- 43 Reserve Independent Schools
- 44 Reserve Library
- 45 Rio Rancho Public Schools
- 46 Roy Municipal Schools
- 47 Ruidoso High School
- 48 Silver Consolidated Schools
- 49 Socorro Data Center
- 50 Taos Academy Charter School
- 51 Tierra Encantada Charter School
- 52 Tularosa Municipal School District
- 53 Vista Grande High School
- 54 Wagon Mound Public Schools
- 55 West Las Vegas School District
- 56 Zuni Public School District

- Questions / Open Discussion

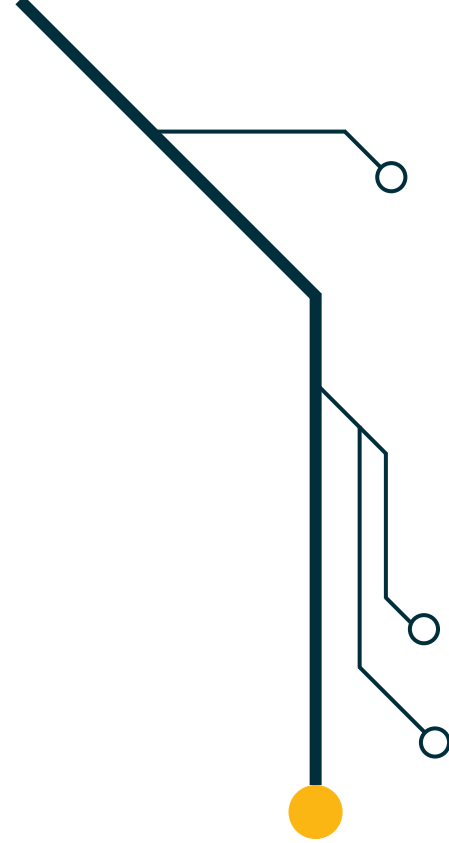

Thanks for your support!

