

SEN ADVISORY COMMITTEE – FEB. 15, 2024

AGENDA

- Broadband Updates
- Statewide Education Network (SEN): Status & Timeline
- School Participants
- Other Items

UPDATES – BROADBAND & OBAE

- Legislative Session
 - PSFA / OBAE: Schools Broadband Program
- Connect NM Fund Grant Applications (March 11)
- Challenge Process & Updated Maps: Number of Unserved
 - connect.nm.gov
- Community Anchor Institutions (CAIs): 1Gbps symmetrical

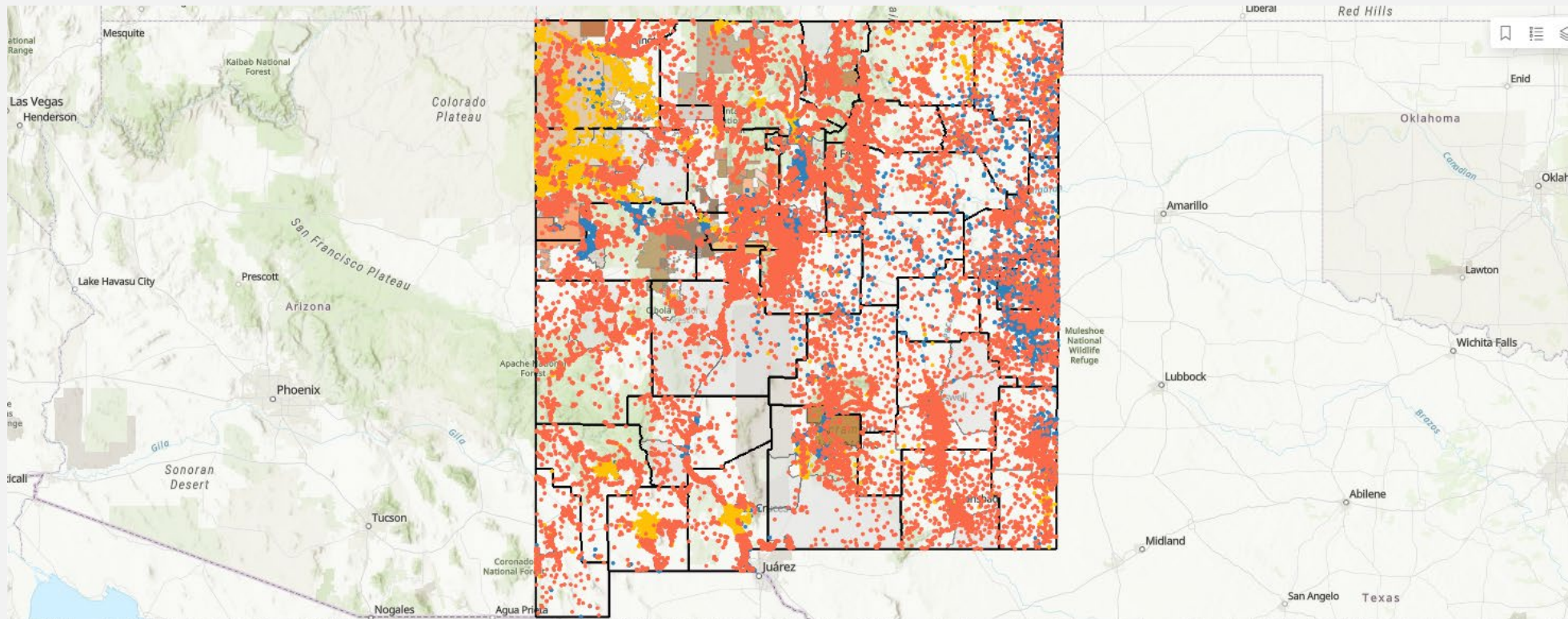

Esri, USGS | Texas Parks & Wildlife, Esri, TomTom, Garmin, FAO, NOAA, USGS, Bureau of Land Management, EPA, NPS, USFWS | Original Data from US Census Bureau TIGER Census Block Groups. National Telecommunications and Information Administration (NTIA) for high-cost area analysis. Powered by

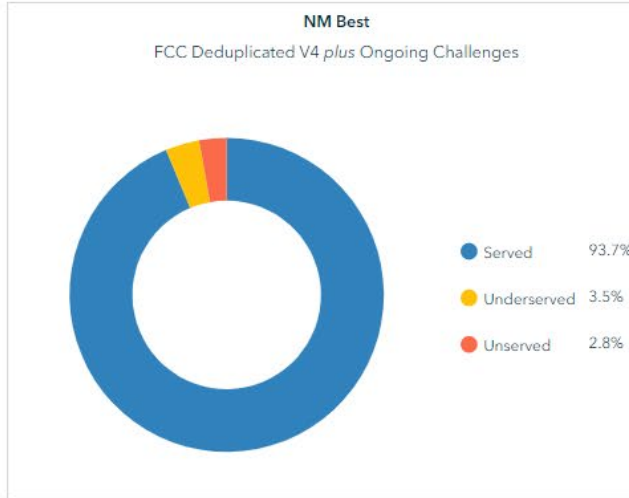
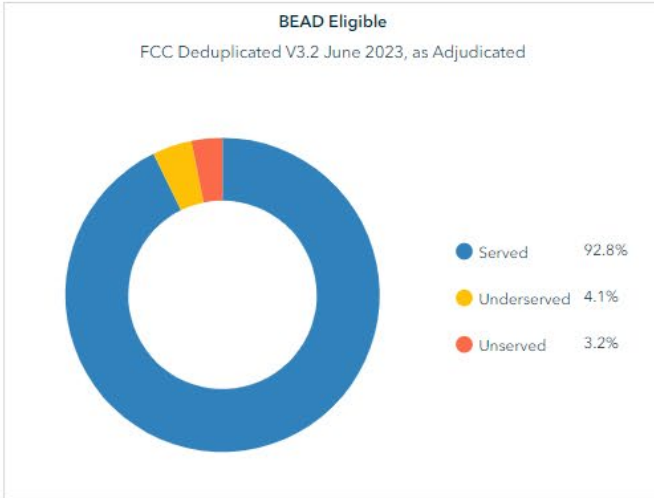
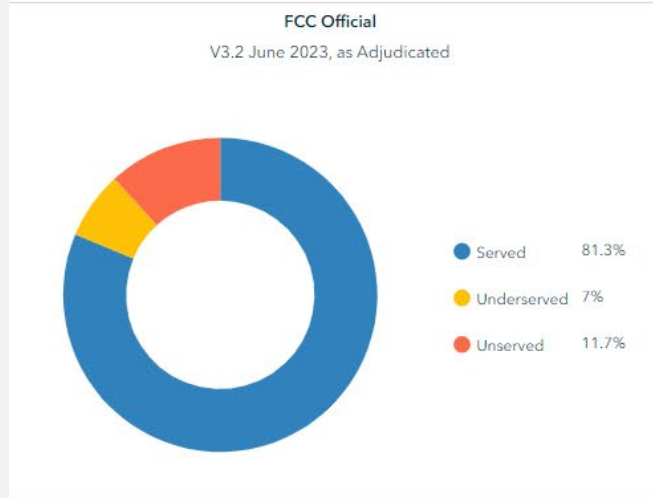

BROADBAND EQUITY ACCESS AND DEPLOYMENT (BEAD)

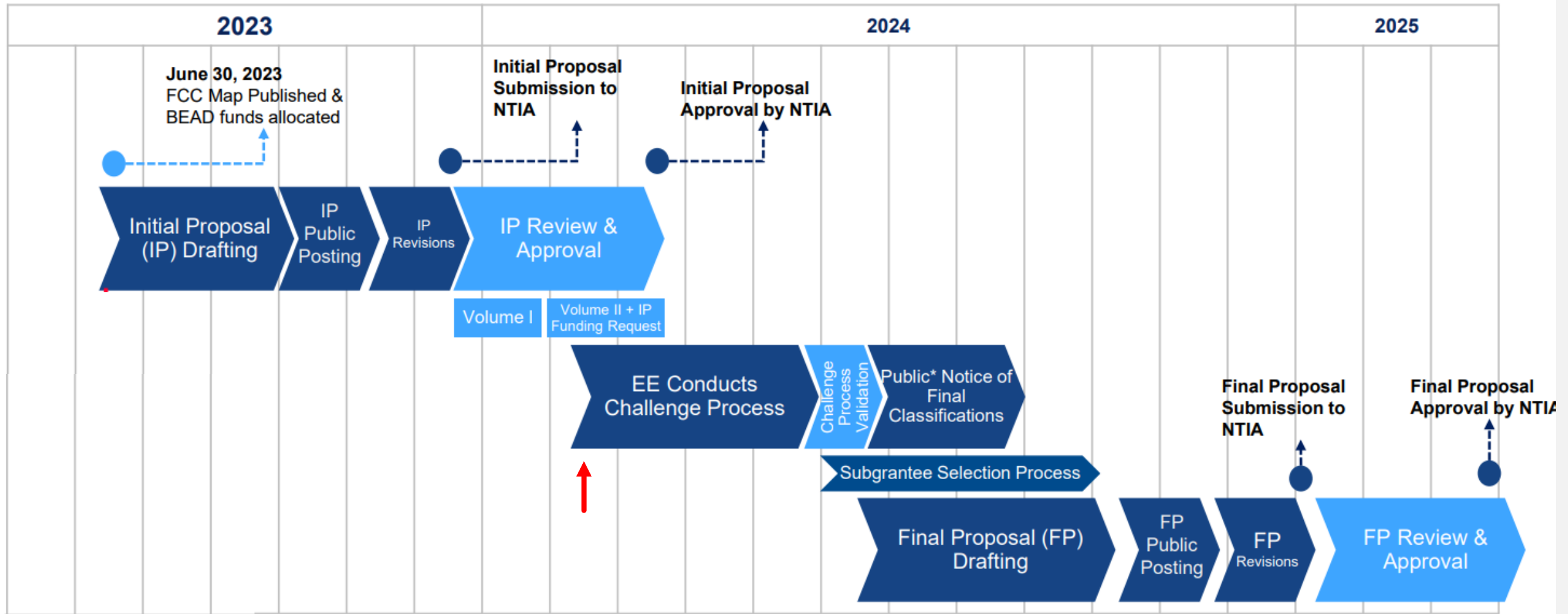

*Per the BEAD NOFO, an Eligible Entity must provide public notice of the final classification of each unserved location, underserved location, or Eligible Community Anchor Institution within the jurisdiction of the Eligible Entity after resolving each challenge and at least 60 days before allocating grant funds for network deployment.



SEN PHASE 1 - OVERVIEW

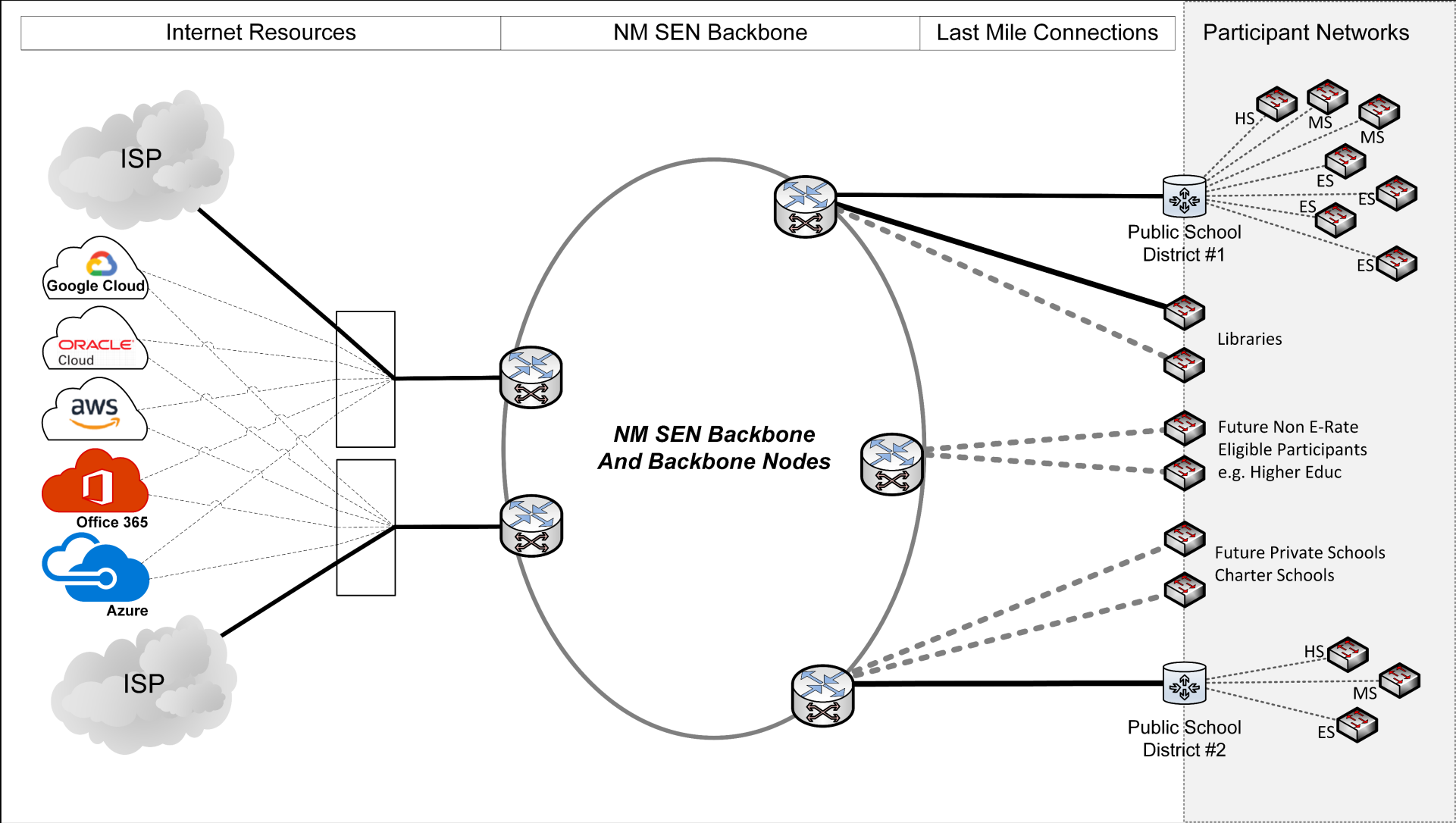

SEN PHASE 1 - OVERVIEW

- SEN 100G Wave (Lumen)
- - - Future State-Coordinated XXXG Wave (YY Vendor) Alternative Path(s)

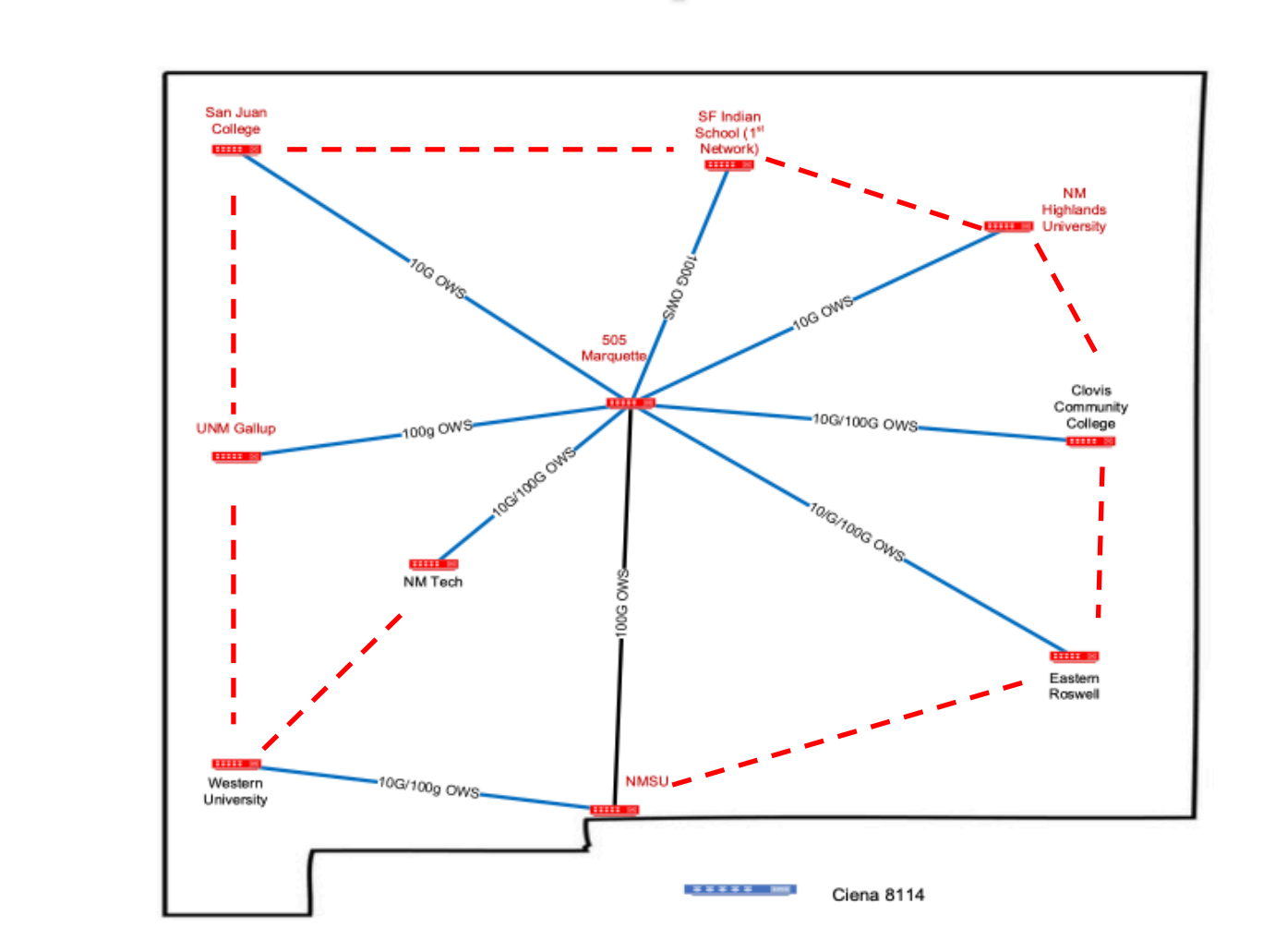

SEN PHASE 1 - OVERVIEW

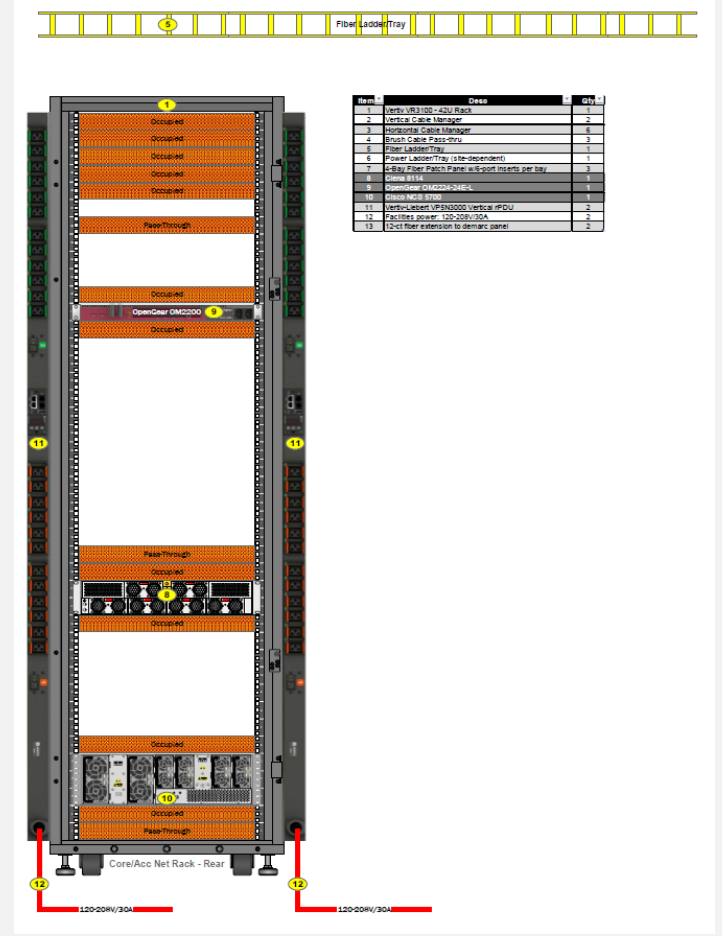
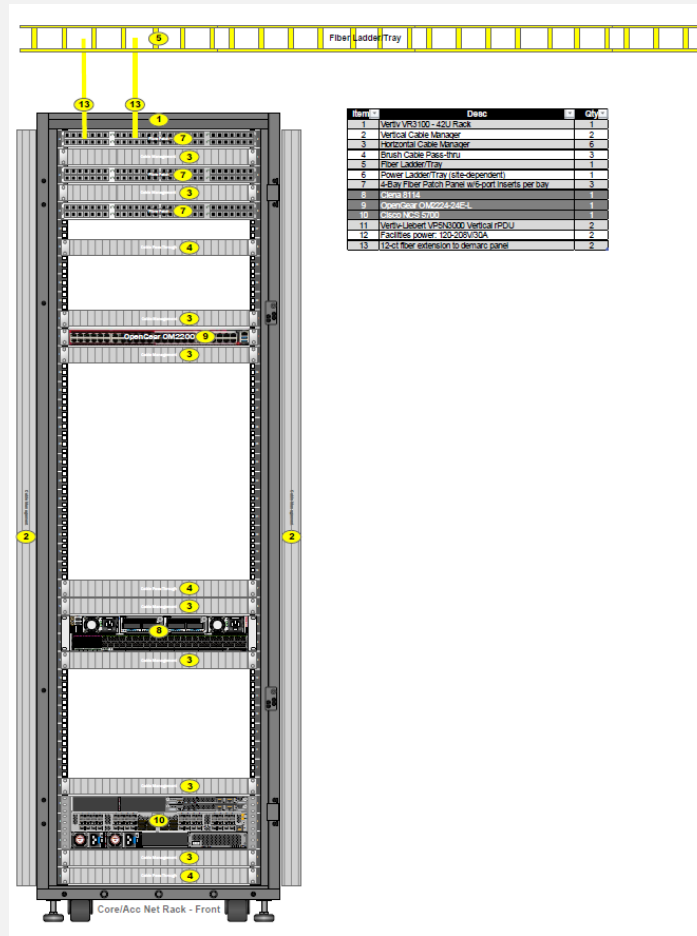
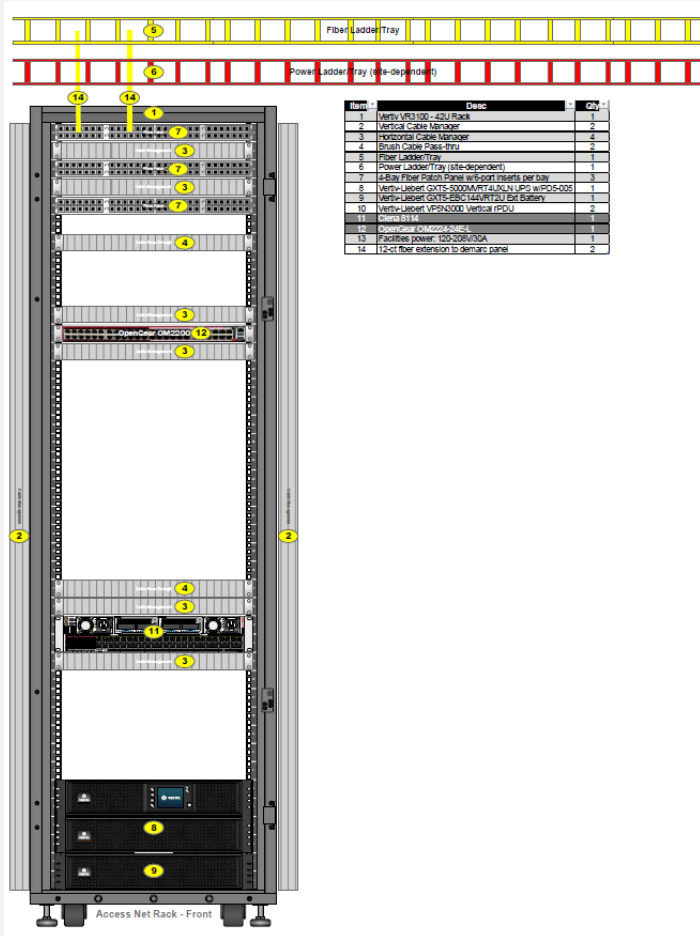

SEN PHASE 1 - STATUS

- ~~High Level Design (HLD) Complete~~
- ~~Secured SEN AS# and IPv6 address block:~~
 - NM SEN (Transport): AS36858
 - /32 IPv6 (~65,536 sites or /48 assignments)
- ~~Commodity Internet Agreements—Finished: Assigning project teams~~
- Developing Low Level (Detailed) Design (LLD): Target Completion | February 2024
 - Working on IPv6 (and IPv4) architecture / assignments
- Testing procedures
- Reviewing Nodes (HigherEd) designs & documentation with participants
 - InterAgencyAgreements with the 10 nodes owners (upgrades and operations): Clovis CC signed
- Finalizing Agreements (Last Mile – Comcast, Conterra, Lumen, Plateau, Unite Private Networks, Windstream)
- DDoS Protection + Intrusion Detection and Prevention (monitoring) tools
- Network Management

SEN PHASE1 - TIMELINE

- December 2023/February 2024 – Finalize InterAgencyAgreemnts (Legal review)
- February / April '24– Circuits ready for provisioning / Complete engineering / K12 Coord.
- March/April '24 – Circuit provisioning / Equipment installation / Testing / K12 Coord.
- April-June '24 (& Ongoing) -> Switchover of Phase1 Participants
- July 1, 2024 -> Operations

SEN PHASE2 – PROCUREMENT STATUS

A. SEQUENCE OF EVENTS

The Procurement Manager will make every effort to adhere to the following schedule:

| Action | Responsible Party | Due Dates |
|---|-------------------------------|-----------------|
| 1. Legal Notice of RFP publication | OBAE | 12/22/2023 |
| 2. Issue RFP | OBAE | 12/21/2023 |
| 3. Acknowledgement of Receipt Form | Potential Offerors | N/A |
| 4. Pre-Proposal Conference | OBAE | 1/4/2024 |
| 5. Deadline to submit Written Questions | Potential Offerors | 1/5/2024 |
| 5. Response to Written Questions | Procurement Manager | 1/9/2024 |
| 7. Submission of Proposal | Potential Offerors | 2/7/2024 |
| 8.* Begin Proposal Evaluation | Evaluation Committee Begins | 2/9/2024 |
| | Ends | 2/16/2024 |
| 9.* Selection of Finalists | Evaluation Committee | 2/20/2024 |
| 10 * Oral Presentation(s) | Finalist Offerors | 2/22/2024 |
| 11.* Best and Final Offers | Finalist Offerors | 2/26/2024 |
| 12.* Finalize Contractual Agreements | OBAE/Finalist Offerors Begins | 2/26/2024 |
| | Ends | 3/8/2024 |
| 13.* Contract Awards | OBAE/ Finalist Offerors | 3/11/2024 |
| 14.* Protest Deadline | OBAE | 3/26/2024 |

*Dates indicated in Events 8 through 14 are estimates only and may be subject to change without needing an amendment to the RFP.

SEN PHASE2 – PROCUREMENT STATUS

- ~58 Participants
- Potential Additional nodes
- Publication Dec. 21st, 2023– through February, 2024 (E-rate...)
- Feb. / March Evaluations & Awards
- March 2024 – E-rate deadline
- Negotiations / Agreements (School Boards approvals) – Participation is Optional

OTHER ITEMS